

Kuwait Corporation Limited

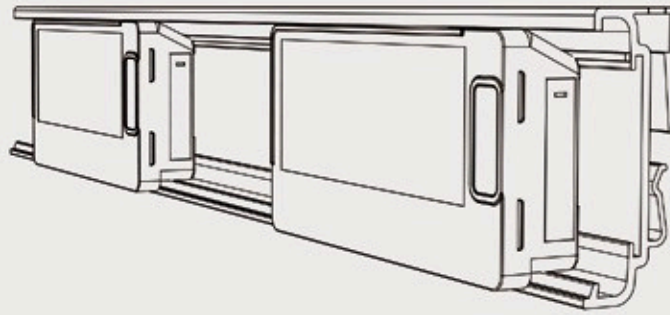
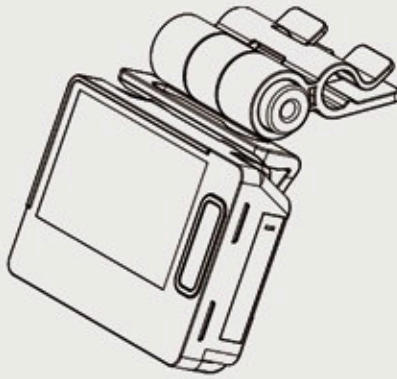

From Paper to ESL Display Solutions

For Pricer

COMPANY PROFILE

Label Solutions Since 2004



We design.

All-in on convenience. Our team connects retailers and ESL brands at the highest industry levels.



We create.

Made the first-class service. We strive to design & manufacture innovative solutions.



Shelf Rails



4

| | |
|-------------------------|----|
| 1.1. 2000 Series Rails | 5 |
| 1.2. MEE Series Rails | 9 |
| 1.3. AS-BS Series Rails | 15 |
| 1.4. Bumper Rails | 23 |
| 1.5. Rail Accessories | 25 |

Multiple Field Accessories



26

| | |
|--|----|
| 2.1. Adapters | 27 |
| 2.2. Peg Hook Supports | 28 |
| 2.3. Clips | 33 |
| 2.4. Ice Stick | 36 |
| 2.5. Table Stand Supports | 37 |
| 2.6. Waterproof Boxes | 40 |
| 2.7. Telescopic Pole Stands | 41 |
| 2.8. Double-side Hanging Display Board | 43 |

Promo System



45

| | |
|-------------------------------|----|
| 3.1. Promotional Accessories | 46 |
| 3.2. Promotional Color Prints | 47 |
| 3.3. Promotional Pockets | 49 |

New Products

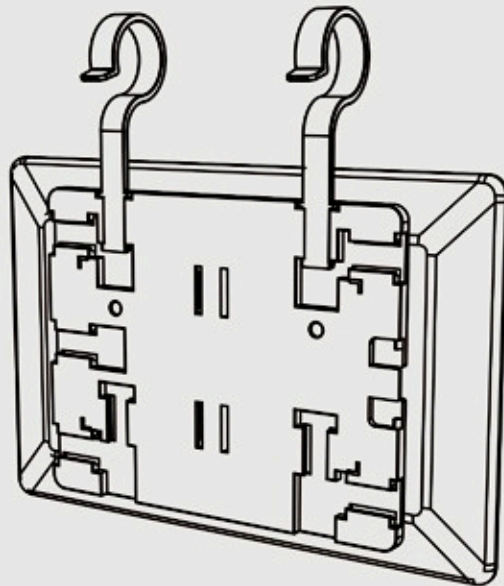
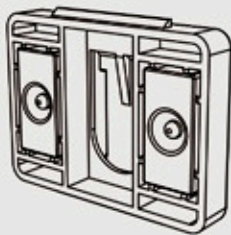

Glass Holder

Code: MEE2002

- Fits 3-10mm Thickness Glass
- With Angle Strip, Display 25°/45°/ 90°
- No Additional Angle Block Required
- With Promo Function
- Length: 48mm



Options:



Promo Card

From Paper to ESL Display Solutions

Paper Sheet

Angle : 90°

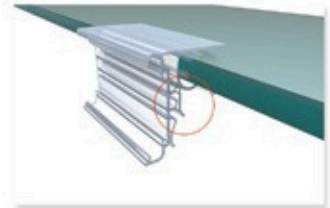

Angle : 25°

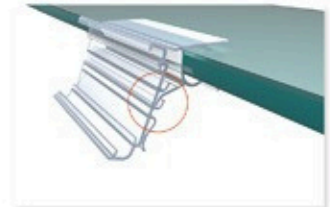

Angle : 45°

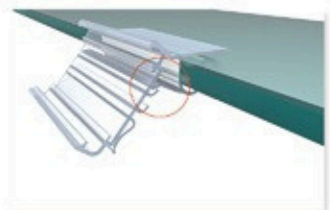

Angle : 90°



Angle : 25°



Angle : 45°



· Innovation



· Design



· Creation

Mini Rail Adapter



Code: MEE-P001



Code: MEE-P002

Hiding Rails to Display ESL Actively

- 1) Fits 3-10mm Glass Shelf of Farmacia
- 2) Fits Thicker Shelf, Under the Shelf
- 3) Clip into the Slot of Flat Shelf
- 4) Mini Piece Displays as Table Stand
- 5) Back Slot Available for Promo Card



Use Underneath



Bottom adhesive



Above adhesive



Use Underneath Thick Panel



Horizontal Display Clipped into Wood



Table Stand



· Innovation



· Design



· Creation

Backing Plate Adapter

Code: REE-P002

- Adapter to Combine with ESL
HD150/ HD200
- Screw/ 3M Tape/ Magnetic

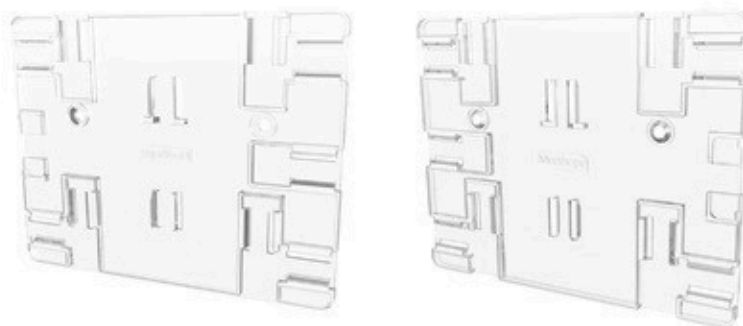

HD200



HD150



Fix Magnetic Tape



Fix Magnetic Block



Screw



Fix S Hook



· Innovation



· Design



· Creation

Rail Block



Code: REE-P003

- Combine with Adapter into Rail
- Magnetic Option

Magnetic Block

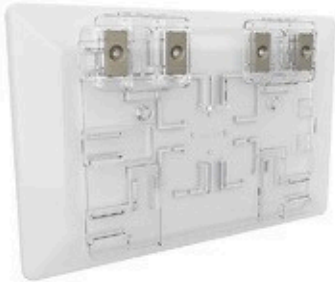

HD200



HD150



HD110



HD L

Clip into Rail



· Innovation



· Design



· Creation

Adapter and Tooling

Code: REE-P001

- Adapter to ESL HD S/ HD M+ / HD L/ HD T
- Screw/ 3M Tape/ Magnetic
- Color: Transparent
- Material: PC

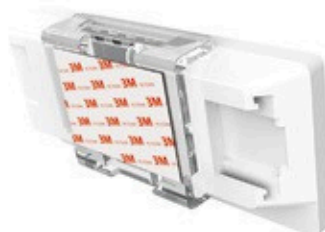
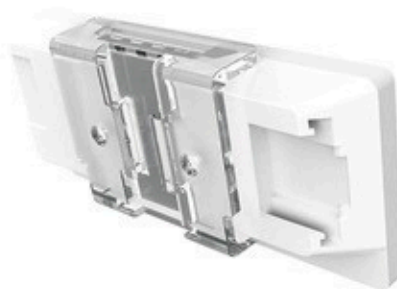

3M Tape

Magnetic

Code: REE-DIS-003

High-Strength Plastic Removal Tooling

Effectively avoid white marks in rail

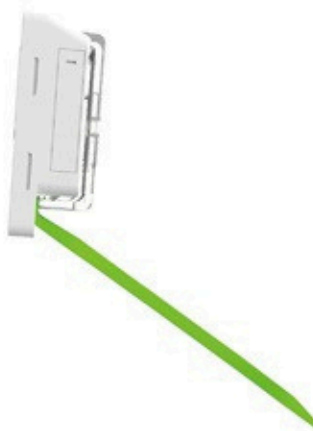

· Innovation



· Design



· Creation

Shelf Rails

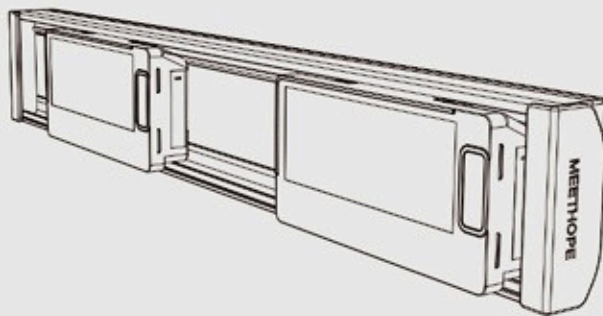

Shelf Rails

1.1. 2000 Series Rails

Code: 200014

- Works with Shelves Tegometal/ Alser/ Cefla System 25 /Linde/ La Fortezza etc.
- Color: Transparent Black Special Color
- Material: PVC
- Length: Customized

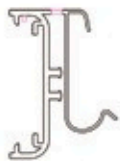

Options:

- Angle Adjuster: N-angle-001
- Bus Stop: REE-POP-001/ REE-POP-002

Other Rails



200013



200019



200021



200023



200025



200026



200029



200030



200035

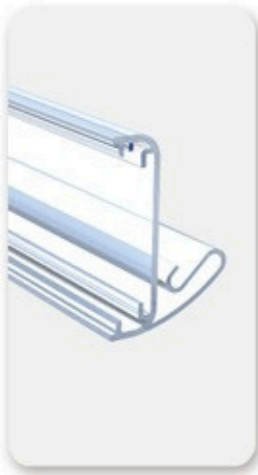

Code: 200013

- No-Tag Shelving, Works with Darling Flat /Syndicate Shelves
- Color: Transparent Black Special Color
- Material: PVC
- Length: Customized
- **Options:**
 - Bus Stop: REE-POP-001/ REE-POP-002



Code: 200019

- Works with C-Channel Shelf
- Color: Transparent Black Special Color
- Material: PVC
- Length: Customized
- **Options:**
 - Angle Adjuster: N-angle-001
 - Bus Stop: REE-POP-001/ REE-POP-002



Code: 200021

- Works with Flat Surface Shelf Thickness from 18mm to 25mm
- Color: Transparent Black Special Color
- Material: PVC
- Length: Customized
- **Options:**
 - Angle Adjuster: N-angle-001
 - Bus Stop: REE-POP-001/ REE-POP-002

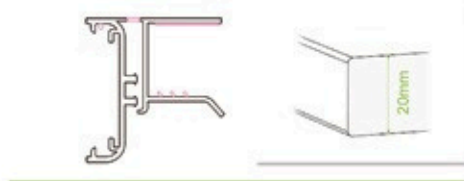

Code: 200023

- Works with Flat Surface Shelf
- Color: Transparent Black
 Special Color
- Material: PVC
- Length: Customized
- **Options:**
 - Angle Adjuster: N-angle-001
 - Bus Stop: REE-POP-001/ REE-POP-002

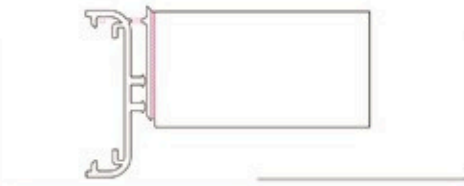

Code: 200025

- Works with Flat Surface Shelf
- Punched Holes or Tape(3M Foam Tape/ Foam Tape/ Acrylic Tape/ Magnet Strip)
- Color: Transparent Black
 Special Color
- Material: PVC
- Length: Customized
- **Options:**
 - Angle Adjuster: N-angle-001
 - Bus Stop: REE-POP-001/ REE-POP-002



Code: 200026

- Works with Slimline Rail
- Color: Transparent Black
 Special Color
- Material: PVC
- Length: Customized
- **Options:**
 - Angle Adjuster: N-angle-001
 - Bus Stop: REE-POP-001/ REE-POP-002



Code: 200029

- Works with Shelves Linde/Tegometal / Alser/ Cefla System 25 /La Fortezza etc.
- Color: Transparent Black Special Color
- Material: PVC
- Length: Customized
- **Options:**
 - Angle Adjuster: N-angle-001
 - Bus Stop: REE-POP-001/ REE-POP-002
 - Proctive Cover: 200035



Code: 200030

- Works with Shelves C-Channel/ Lozier/ Streater/Alser Innovation V4/ Madix/ Hermes Metal e Yudigar/ P25 (HMY) / La Fortezza F25 etc.
- Color: Transparent Black Special Color
- Material: PVC
- Length: Customized
- **Options:**
 - Angle Adjuster: N-angle-001
 - Bus Stop: REE-POP-001/ REE-POP-002
 - Proctive Cover: 200035



Code: 200035

- Protective Cover
- Work with Rail Code: 200029/ 200030
- Color: Transparent
- Material: PVC
- Length: Customized

Shelf Rails

1.2. MEE Series Rails

PATENTED

Code: MEE1801

- Works with Flat Surface Shelf
- Punched Holes or Tape(3M Foam Tape/ Foam Tape/ Acrylic Tape/ Magnet Strip)
- Color: Transparent Black Special Color
- Material: PVC
- Length: Customized



Options:

- Angle Adjuster: Z-angle-001
- Rail End Cap: REE-M001
- Bus Stop: REE-POP-001/ REE-POP-002

Other Rails



MEE1803



MEE1806



MEE1807



MEE1810



MEE1901



MEE1902



MEE1903



MEE-EUR001



MEE1919



MEE1920



MEE1921



MEE1922



MEE1925



Code: MEE1803

- Protective Cover / Bumper Rail
- Tape: 3M Foam Tape/Foam Tape/ Acrylic Tape
- Color: Transparent Black
- Special Color
- Material: PVC
- Length: Customized
- **Options:**
- Angle Adjuster: Z-angle-001
- Compatible with BS Series Rails



Code: MEE1806

- Works with Shelves Linde/Tegometal / Alser/ Cefla System 25 /La Fortezza etc.
- Color: Transparent Black
- Special Color
- 2 Different Angles Available
- Material: PVC
- Length: Customized
- **Options:**
- Angle Adjuster: Z-angle-001
- Rail End Cap: REE-M001
- Bus Stop: REE-POP-001/ REE-POP-002

How to use



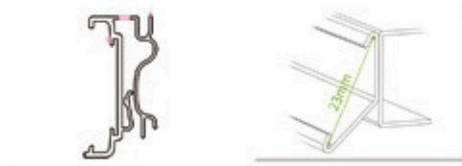

Code: MEE1807

- Works with C-Channel Shelf
- Color: Transparent Black Special Color
- Material: PVC
- Length: Customized
- **Options:**
 - Angle Adjuster: Z-angle-001
 - Rail End Cap: REE-M001
 - Bus Stop: REE-POP-001/ REE-POP-002

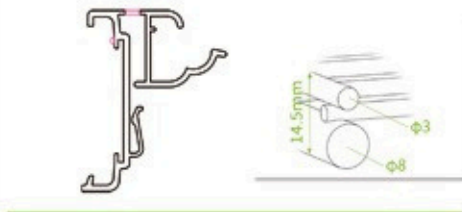

Code: MEE1810

- Works with Shelves Wanzl/ Kinder KS etc.
- Color: Transparent Black Special Color
- 2 Different Angles Available
- Material: PVC
- Length: Customized
- **Options:**
 - Angle Adjuster: Z-angle-001
 - Rail End Cap: REE-M001
 - Bus Stop: REE-POP-001/ REE-POP-002

How to use





Code: MEE1901

- Works with Shelves C-Channel/ Lozier/ Streater/ Alser Innovation V4/ Madix/ Hermes Metal e Yudigar/ P25 (HMY) / La Fortezza F25 etc.
- Color: Transparent Black Special Color
- Material: PVC
- Length: Customized
- **Options:**
 - Angle Adjuster: Z-angle-001
 - Rail End Cap: REE-M001
 - Bus Stop: REE-POP-001/ REE-POP-002



Code: MEE1902

- Works with Shelves C-Channel/ Lozier/ Streater/ Alser Innovation V4/ Madix/ Hermes Metal e Yudigar/ P25 (HMY) / La Fortezza F25 etc.
- Color: Transparent Black Special Color
- Material: PVC
- Length: Customized
- **Options:**
 - Angle Adjuster: Z-angle-001
 - Rail End Cap: REE-M001
 - Bus Stop: REE-POP-001/ REE-POP-002



Code: MEE1903

- Works with Shelf Cefla System 25
- Color: Transparent Black Special Color
- Material: PVC
- Length: Customized
- **Options:**
 - Angle Adjuster: Z-angle-001
 - Rail End Cap: REE-M001
 - Bus Stop: REE-POP-001/ REE-POP-002



Code: MEE-EUR001

- Works with Shelves C-Channel/ Lozier/ Streater/Alser Innovation V4/ Madix/ Hermes Metal e Yudigar/ P25 (HMY) / La Fortezza F25 etc.
- Color: Transparent Black Special Color
- Material: PVC
- Length: Customized
- **Options:**
 - Angle Adjuster: Z-angle-001
 - Bus Stop: REE-POP-001/ REE-POP-002



Code: MEE1919

- Works with Shelves C-Channel/ Lozier/ Streater/Alser Innovation V4/ Madix/ Hermes Metal e Yudigar/ P25 (HMY) / La Fortezza F25 etc.
- Color: Transparent Black Special Color
- Material: PVC
- Length: Customized
- **Options:**
 - Angle Adjuster: Z-angle-001
 - Rail End Cap: REE-M001
 - Bus Stop: REE-POP-001/ REE-POP-002



Code: MEE1920

- Works with Flat Surface Shlef
- Color: Transparent Black Special Color
- Material: PVC
- Length: Customized
- **Options:**
 - Angle Adjuster: Z-angle-001
 - Rail End Cap: REE-M001
 - Bus Stop: REE-POP-001/ REE-POP-002



Code: MEE1921

- Works with Wire Shelf
- Color: Transparent Black Special Color
- Material: PVC
- Length: Customized
- **Options:**
 - Angle Adjuster: Z-angle-001
 - Rail End Cap: REE-M001
 - Bus Stop: REE-POP-001/ REE-POP-002

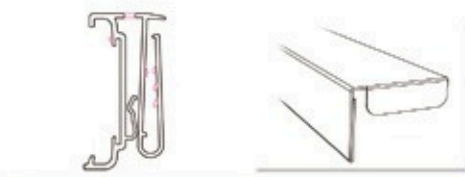

Code: MEE1922

- Works with Flat Shelf, for None Tape Option
- Color: Transparent Black Special Color
- Material: PVC
- Length: Customized
- **Options:**
 - Angle Adjuster: Z-angle-001
 - Rail End Cap: REE-M001
 - Bus Stop: REE-POP-001/ REE-POP-002



Code: MEE1925

- Works with Shelves C-Channel/ Lozier
- Works with 8mm Wire Shelves & Different C-Channel Shelves from 11mm to 30mm
- Color: Transparent Black Special Color
- Material: PVC
- Length: Customized
- **Options:**
 - Angle Adjuster: Z-angle-001
 - Rail End Cap: REE-M001
 - Bus Stop: REE-POP-001/ REE-POP-002

Shelf Rails

1.3. AS-BS Series Rails

Code: AS001-AS002

- Works with Shelves Tegometal/ Alser/ Cefla System 25 / Linde/ La Fortezza etc.
- Color: Transparent Black Special Color
- Material: PVC
- Length: Customized



How to use



- AS001-AS002
- AS001 & Paper Label Holder



- Short AS001 with Long Paper Label Holder



- Short AS001 with Long AS002



- Long AS001 with Long AS002



- With POP Cards



Code: AS-H005

- Works with Flat Surface Shelf
- Tape: 3M Foam Tape/ Foam Tape/ Acrylic Tape/ Magnet Strip
- Color: Transparent Black Special Color
- Length: Customized
- Material: PVC

- Short rail for single ESL application
- Long rail for multi ESL application

How to Use

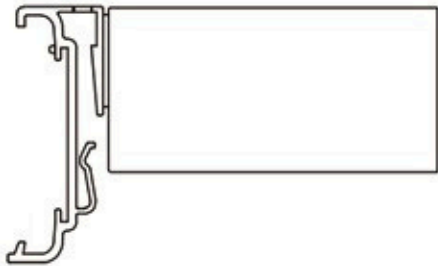

- With adhesive tape



- AS-H005 assembled with different shelf rails

Other Rails



BS-R001



BS-LF002



BS-TEG003



BS-004



BS-005



BS-006



BS-CS007



BS-WZ008



BS-009



BS-FZ010



BS-PB011



BS-012



BS-WMT013



BS-INT014



Code: BS-R001

- Fits Rail Code AS-H005
- Works with Shelves C-Channel/ Lozier/ Alser Innovation V4/ Madix/ Streater/ Hermes Metal e Yudigar/ P25 (HMY) / La Fortezza F25 etc.
- Color: Transparent Black Special Color
- Material: PVC
- Length: Customized



Code: BS-LF002

- Fits Rail Code AS-H005
- Works with Shelves C-Channel/ Lozier/ Streater/ Alser Innovation V4/ Madix/ Hermes Metal e Yudigar P25 (HMY) / La Fortezza F25 etc.
- Color: Transparent Black Special Color
- Material: PVC
- Length: Customized



Code: BS-TEG003

- Fits Rail Code AS-H005
- Works with Shelves Linde/Tegometal/ Alser/Cefla System 25/ La Fortezza etc.
- 2 Different Angles Available
- Color: Transparent Black Special Color
- Material: PVC
- Length: Customized

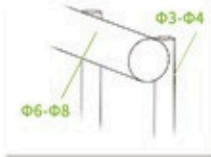
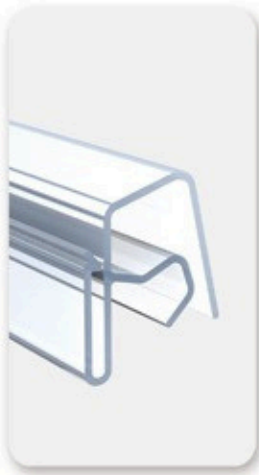

Code: BS-004

- Fits Rail Code AS-H005
- Works with Wire/ Wire Basket/ Box etc.
- Color: Transparent Black
 Special Color
- Material: PVC
- Length: Customized

Use

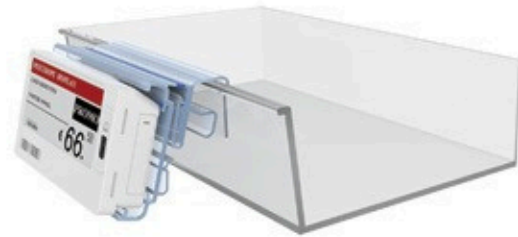

Code: BS-005

- Fits Rail Code AS-H005
- Works with Flat Shelf
- Color: Transparent Black
 Special Color
- Material: PVC
- Length: Customized



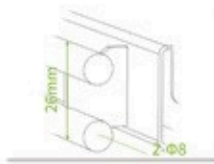
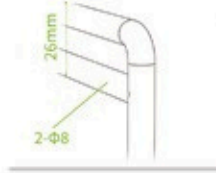

Code: BS-006

- Fits Rail Code AS-H005
- Works with Shelves Double-Wire/ Alser/ Cefla System 25/ La Fortezza etc.
- Color: Transparent Black Special Color
- Material: PVC
- Length: Customized

Use



Code: BS-CS007

- Fits Rail Code AS-H005
- Works with Shelf Cefla System 25
- Color: Transparent Black Special Color
- Material: PVC
- Length: Customized



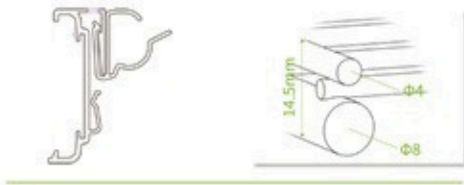
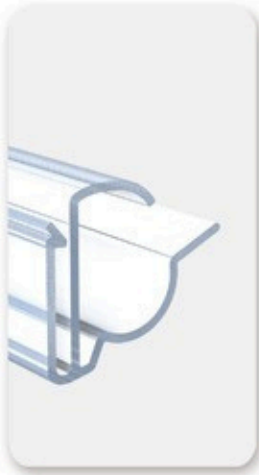

Use 1

Code: BS-WZ008

- Fits Rail Code AS-H005
- Works with Shelves Double Wire/ Wanzl/ Alser/ Cefla Syestem 25/ La Fortezza ect.
- Color: Transparent Black Special Color
- Material: PVC
- Length: Customized



Use 2



Use 3



Code: BS-009

- Fits Rail Code AS-H005
- Works with Flat Surface Shelf Thickness from 16 to 30mm
- Color: Transparent Black Special Color
- Material: PVC
- Length: Customized

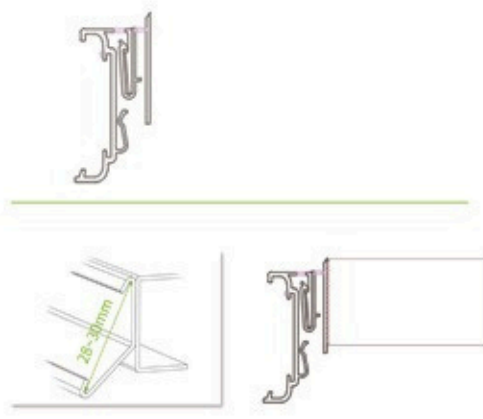

Code: BS-PB011

- Fits Rail Code AS-H005
- Works with Flat Surface Shelf/ C-Channel Shelf
- Punched Holes or Tape(3M Foam Tape/ Foam Tape/ Acrylic Tape/ Magnet Strip)
- Color: Transparent Black Special Color
- Material: PVC
- Length: Customized

Use

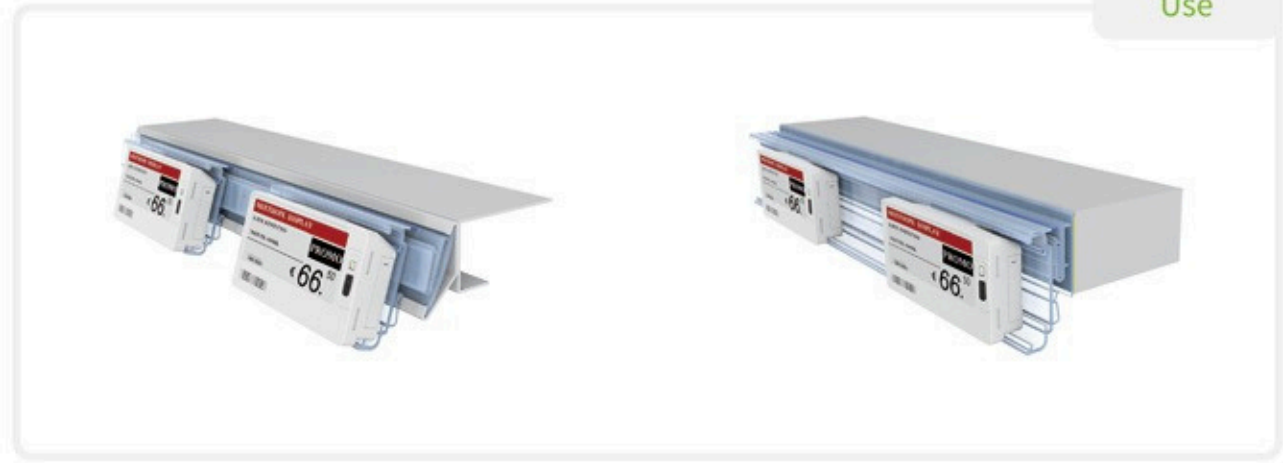

Use

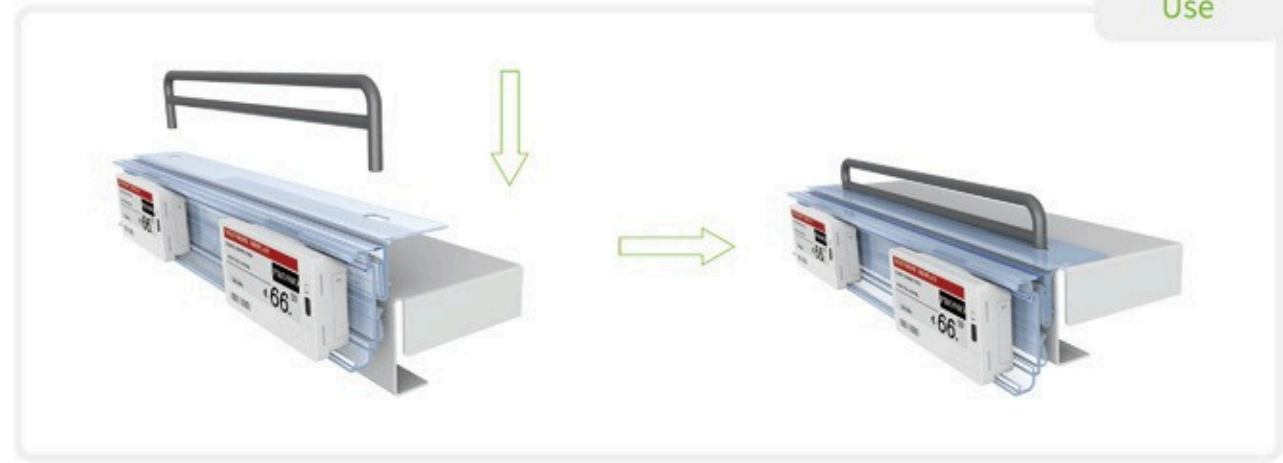



Code: BS-012

- Fits Rail Code AS-H005
- Color: Transparent Black
 Special Color
- Material: PVC
- Length: Customized



Code: BS-WMT013

- Fits Rail Code AS-H005
- No-Tag Shelving, Works with Darling Flat/ Syndicate Shelves
- Color: Transparent Black
 Special Color
- Material: PVC
- Length: Customized

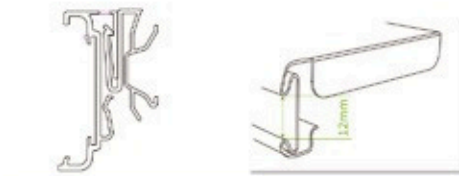

Code: BS-INT014

- Fits Rail Code AS-H005
- Works with Shelf InTrac IMZ25 V13
- Color: Transparent Black
 Special Color
- Material: PVC
- Length: Customized

Shelf Rails

1.4. Bumper Rails

Code: BS-FZ010

- Fits Rail AS-H005
- Works with Flat Surface Shelf
- Punched Holes or Tape(3M Foam Tape/Acrylic tape)
- Color: Transparent Black Special Color
- Material: PVC
- Length: Customized



Protect ESL from accidental damage by shopping carts

Other Rails

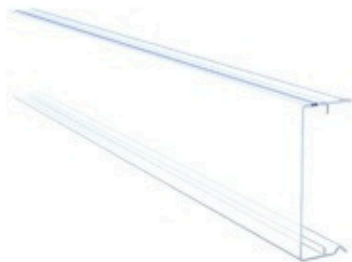

200035



MEE1803



MEE1925 + MEE1927

Shelf Rails

1.5. Rail Accessories

Code: REE-M001

- Works with Shelf Rails
- Rail End Cap, to Protect Customers from being Scratched
- Color: Transparent
- Material: PC



CODE:REE-DIS-002



CODE:Z-ANGLE-001



- Way of use 1: 30°

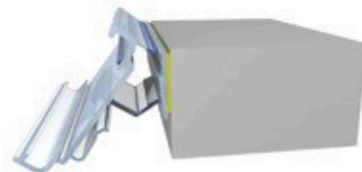

- Way of use 2: 40°

CODE:N-ANGLE-001



- Way of use 1: 30°



- Way of use 2: 40°

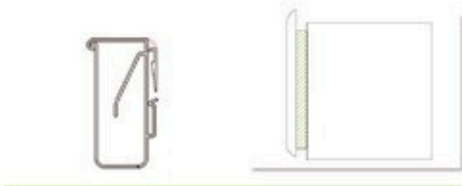

Code: MEE1803

- Protective Cover / Bumper Rail
- Tape: 3M Foam Tape/Foam Tape/Acrylic Tape
- Color: Transparent Black Special Color
- Material: PVC
- Length: Customized
- **Options:**
 - Angle Adjuster: Z-angle-001
 - Compatible with BS Series Rails



Code: 200035

- Protective Cover
- Work with Rail Code: 200029/ 200030
- Color: Transparent
- Material: PVC
- Length: Customized



Code: MEE1925 + MEE1927

- Protective Cover / Bumper Rail
- Works with 8mm Wire Shelves & Different C-Channel Shelves from 11mm to 30mm
- Color: Transparent Black Special Color
- Material: PVC
- Length: Customized
- **Options:**
 - Angle Adjuster: Z-angle 001
 - Rail End Cap: REE-M001
 - Bus Stop: REE-POP-001/ REE-POP-002

Multiple Field Accessories

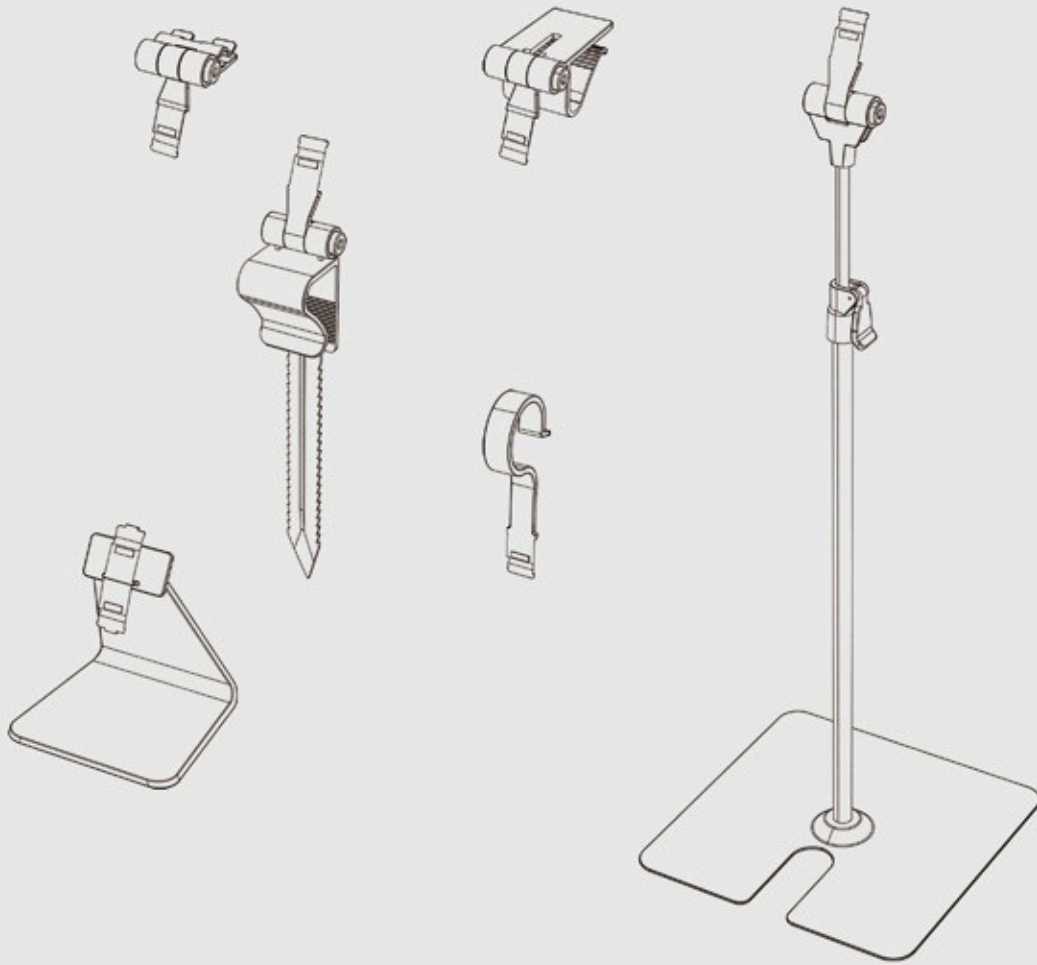

Multiple Field Accessories

2.1. Adapters

Code: REE-H001

- Adapter to Combine ESL and REE Series Accessories
- ESL Size: 1.54"/2.13"/2.9"
- Color: Transparent
- Material: PC



Code: REE-P001

- Adapter to Combine ESL and REE Series Accessories
- Screw/ 3M Tape/ Magnetic Strip
- ESL Size: 1.54"/2.13"/2.9"
- Color: Transparent
- Material: PC



PE Foam Tape

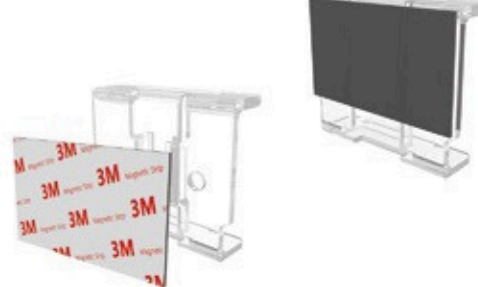

Magnetic Strip

Tape

Multiple Field Accessories

2.2. Peg Hook Supports

PATENTED



Options:

- REE001-S6: for Φ 3-6mm T hook
- REE001-S8: for Φ 6-8mm T hook

Code: REE001-S6
Code: REE001-S8

- T-peg Hook Supports
- Works with Adapter
- Material: PC
- Color: Transparent
- Adjusted Angle Function
- Options:
 - Adapter Code: REE-H001
 - Adapter Code: REE-P001

How to adjust the angle

Angle Adjusted through Pressing the Button

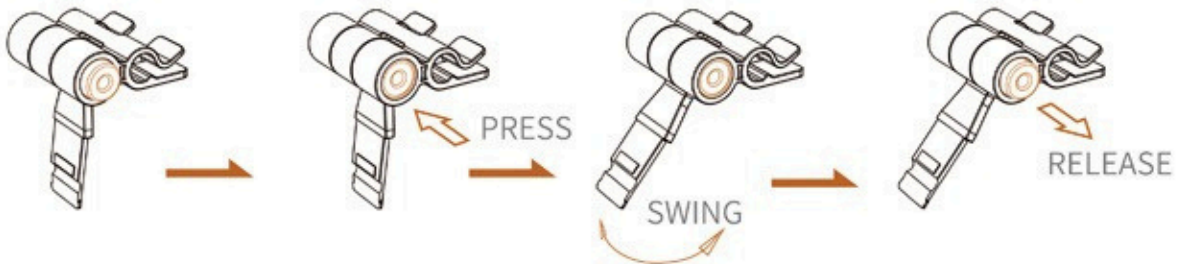

PATENTED

Code: REE009

- L-peg Hook Support
- Works with Adapter
- Adjusted Angle Function
- 2 Different L Hook Wires:
Φ6mm & Φ8mm
- Color: Transparent
- Material: PC
- Options:
 - Adapter Code: REE-H001
 - Adapter Code: REE-P001

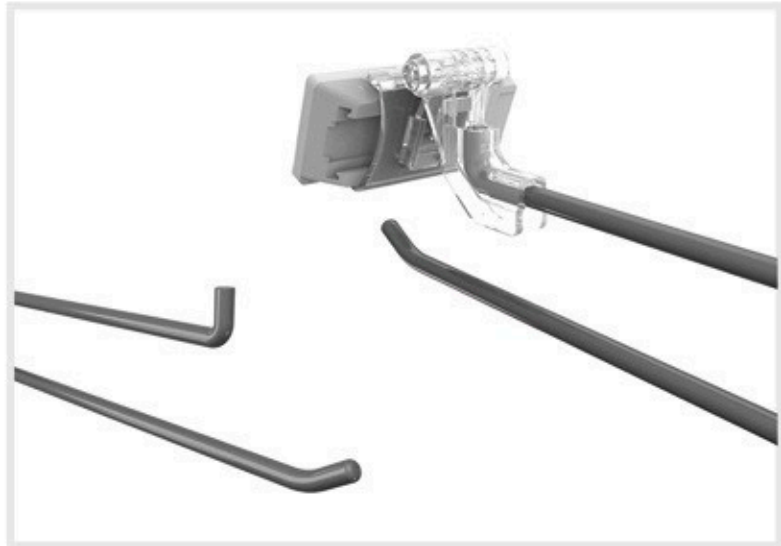
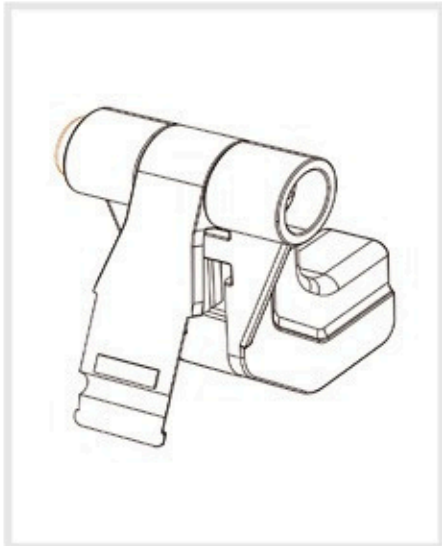
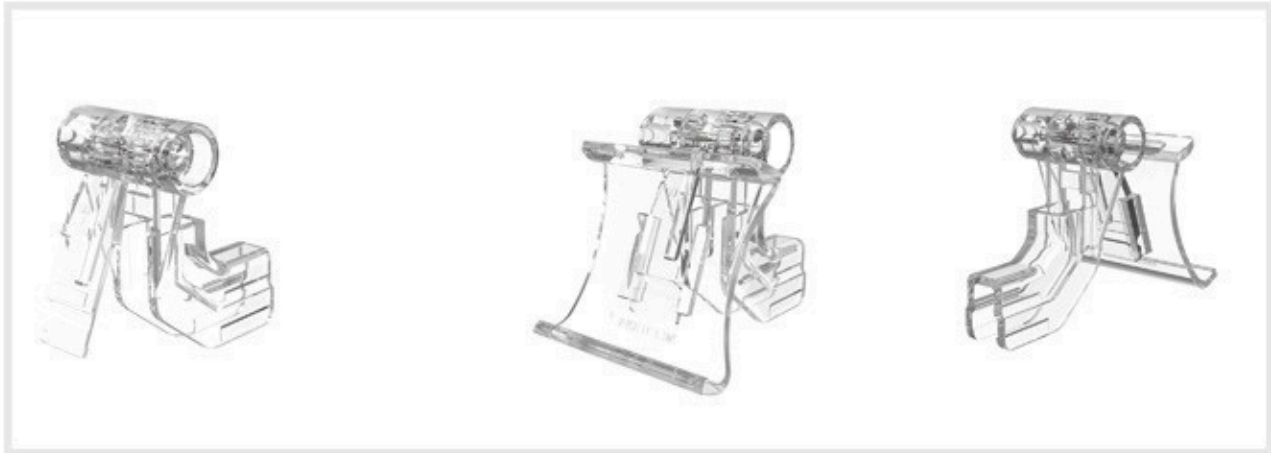

PATENT
PENDING



Code: REE-M007

- Peg Hook
- L-peg Hook Supports
- Works with Adapter
- Color: Transparent
- Material: PP

Options:

- Adapter Code: REE-H001
- Adapter Code: REE-P001



• 8 Sizes for 2 Different Structure Wires:

- 1.) for Φ 0.149" (around ϕ 3.78mm)
- 2.) for Φ 0.186" (around ϕ 4.72mm)
- 3.) for Φ 0.212" (around ϕ 5.38mm)
- 4.) for Φ 0.250" (around ϕ 6.35mm)

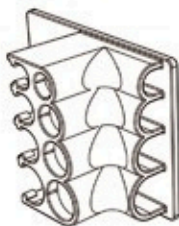
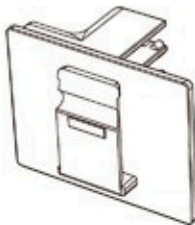

Code: REE-M003

- Hook Hanger ϕ 25mm
- Available for Pole Max Φ 30mm
- Color: Transparent
- Material: PC



Case





Options:

- Adapter Code: REE-H001
- Adapter Code: REE-P001

Code: REE-M012

- Metal Wire Hanger without Angle Adjusted Function
- Works with Adapter
- Available for Different Poles: $\Phi 3\text{mm}$ to $\Phi 10\text{mm}$
- Color: Transparent
- Material: PC



Case



Multiple Field Accessories

2.3. Clips

Code: REE003-A

- Works with Adapter
- Horizontal Clip for Flat Surface
Thickness 12-20mm
- Color: Transparent
- Material: PC
- Options:
 - Adapter Code: REE-H001
 - Adapter Code: REE-P001

PATENTED



Case





Code: REE004-B

- Vertical Clip for Flat Surface
- Thickness 12-20mm
- Color: Transparent
- Material: PC
- Works with Adapter

Options:

- Adapter Code: REE-H001
- Adapter Code: REE-P001



Case



Code: REE-Clip-007

- Universal Clamp Clip for Flat Shelf/ Wire Basket/ Wire etc.
- Clip Mouth Width: 0-34mm
- Rotable Angles by Two Joints
- Color:
 Gray Special Color
- Material: ABS



Multiple Field Accessories

2.4. Ice Stick

PATENTED



Code: REE002

- Depth: 110mm
- Material: PC
- Color: Transparent
- Works with Adapter
- Ice Pin for Frozen Area



Multiple Field Accessories

2.5. Table Stand Supports

Code: REE008

- Small Table Stand Support
- Works with Adapter
- Color: Transparent
- Material: PC
- Options:
 - Adapter Code: REE-H001
 - Adapter Code: REE-P001

PATENTED

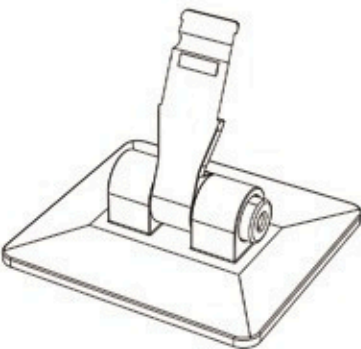

Case

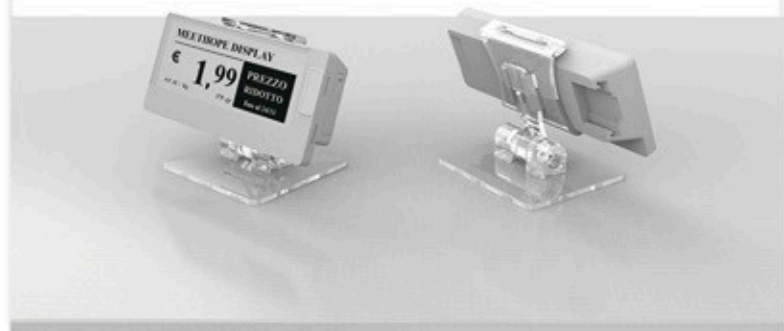



Code: REE-M002

- Table Stand Support
- Works with Adapter
- Color: White Gray
 Special Color
- Material: PC
- ESL Size: 4.2"/7.5"

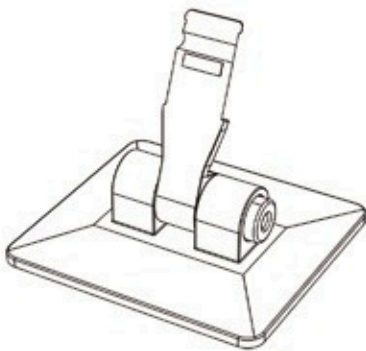

Case



Code: REE-M004

- Table Stand Support for Deli Area
- Works with Adapter /
- Waterproof Box Code REE-M005
- Height: 75mm
- Color: Transparent
 Special Color
- Material: PC
- ESL Size: 2.13"/2.9"



Case



Multiple Field Accessories

2.6. Waterproof Boxes

PATENT
PENDING



Code: REE-M005

- Waterproof Box with Fixed Card for ESL Size: 2.13"/ 2.9"
- Protect ESL away from Water / Stains etc.
- 2 Different Pin Sizes:
 - 9mm & 11mm
- 6 POP Card Slots for Promotion
- Color: Transparent
- Material: PC

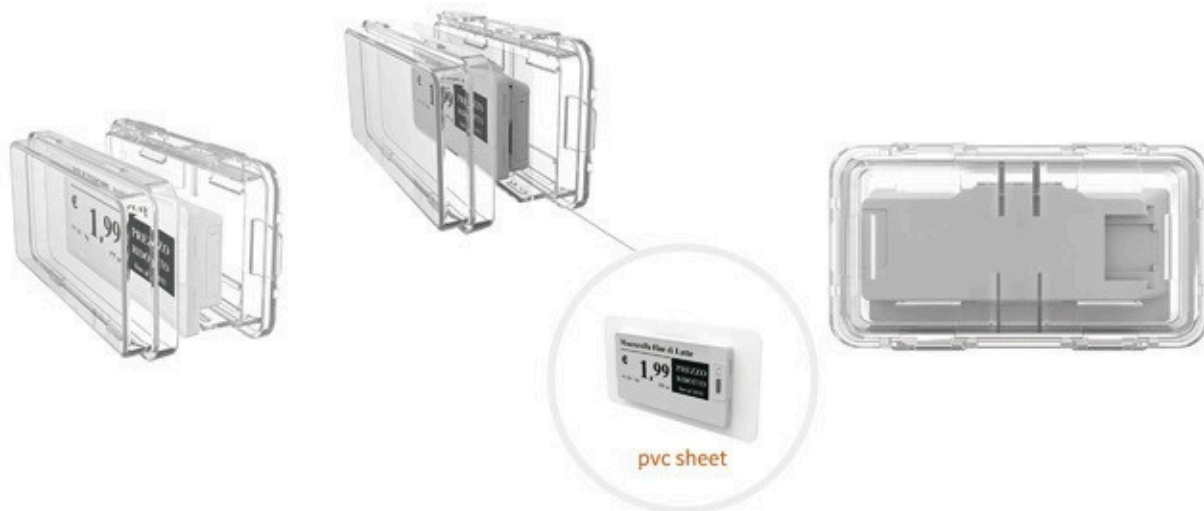

Multiple Field Accessories

2.7. Telescopic Pole Stands

Code: REE006-B

- Telescopic Pole Stand for ESL Size 4.2" / 7.5"
- Base Size: 135mm x 135mm
- Material: Steel & PC
- Color: Black
- Height Options:
 - Min 150mm to max 280mm
 - Min 280mm to max 480mm





Code: REE010

- Double Side Telescopic Pole Stand
- Base Size: 200mm x 200mm
- Material: Steel & PC
- Color: Black

Height Options:

- min 450mm to max 750mm
- min 700mm to max 1300mm



- Double-side Slots Installed with 2 Adapters back to back



450-750mm

Multiple Field Accessories

2.8. Double-side Hanging Display Board

Code: REE-M010-S

- Fits ESL Size 7.5"
- Promotion paper size: 200*75mm
- Frame Size: 245*210*37mm

Code: REE-M010-L

- Fits ESL Size 7.5"
- Promotion paper size: 200*134mm
- Frame Size: 316*210*37mm



- Dual Screen Display
- Avoid Water Splashed
- Double-Sided Promotion



Code: REE-M010-S



Code: REE-M010-L



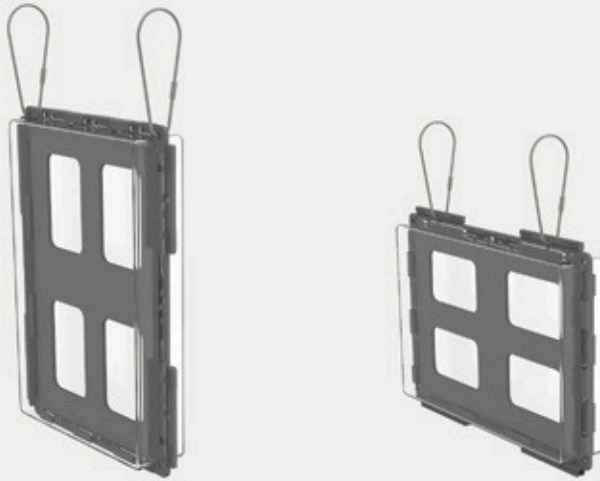

Code: REE-M010

- Fits ESL Size 7.5"
- No Promotion
- Double-Side ESL Hanging
- Options: Vertical & Horizontal
- Color: Gray
- Material: PC
- Frame Size:
160*210*37mm



Vertical



Horizontal



Promo System

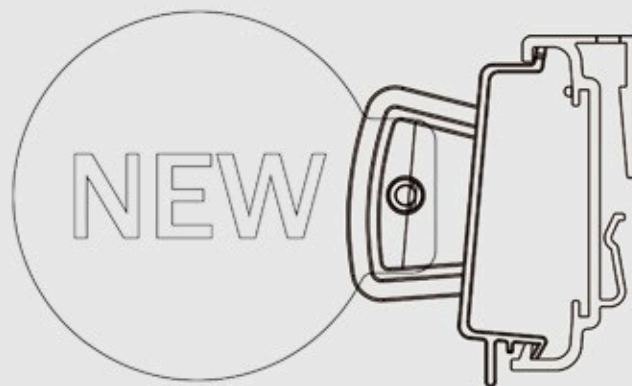
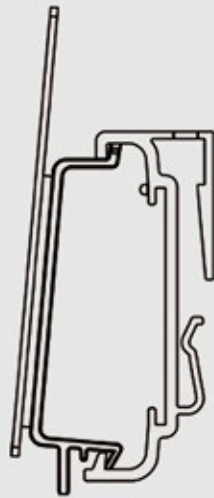

■ Promo System

3.1. Promotional Color Prints

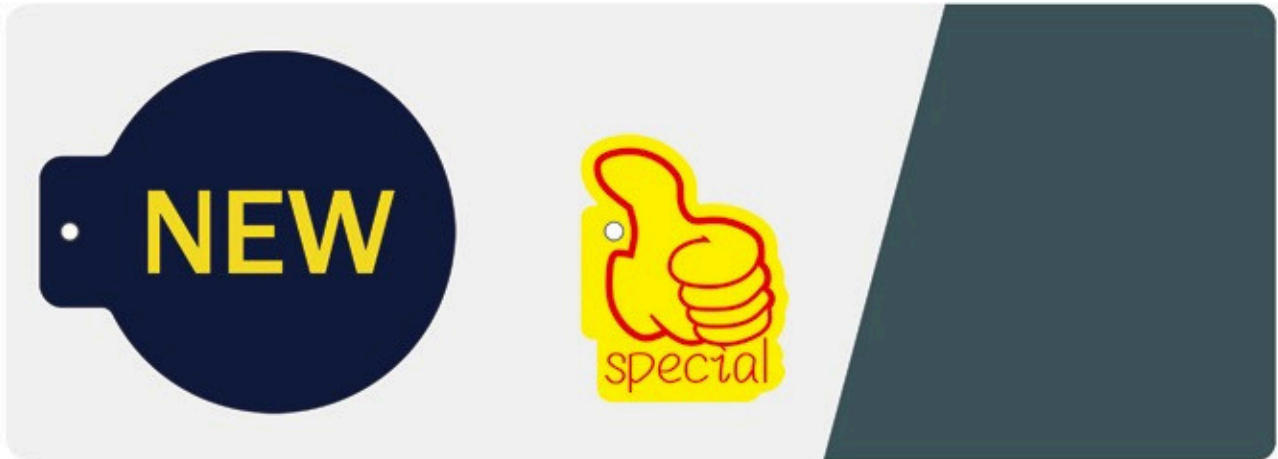

Code: PEE-PPPS01



Code: PEE-PPPM01



Code: PEE-PPPL01



Code: PEE-PPM004



Code: PEE-PPM005

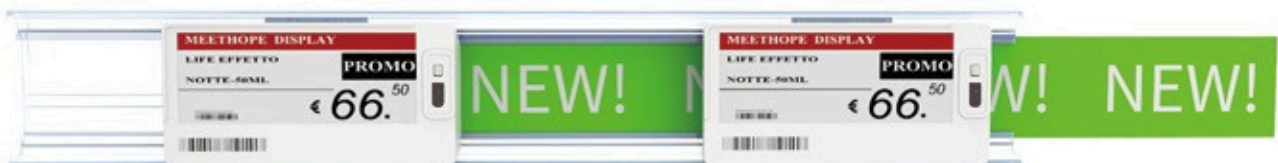

Rail with Color Printed Paper

■ Promo System

3.2. Promotional Accessories

Code: REE-POP001

- Fits Pricer Rails
- Promotional Accessories
- Material: PC

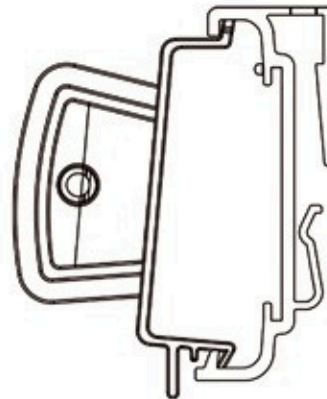

Code: REE-POP002

- Fits Pricer Rails
- Promotional Accessories
- Material: PC

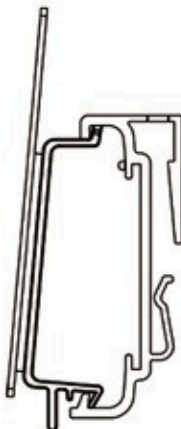



Code: 100010

- Fits BS Series Rails
- Promotional Accessories
- Material: PVC

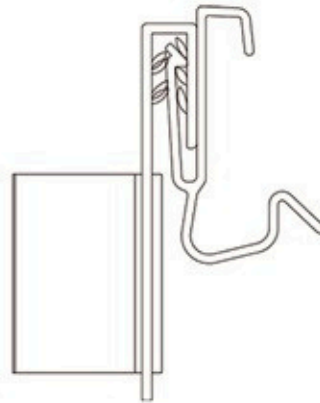

Code: MEE1805

- Fits Pricer Rails
- Promotional Accessories
- Material: PVC



/// Promo System

3.3. Promotional Pockets

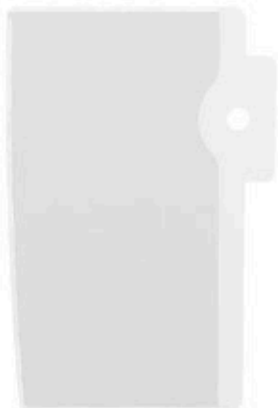
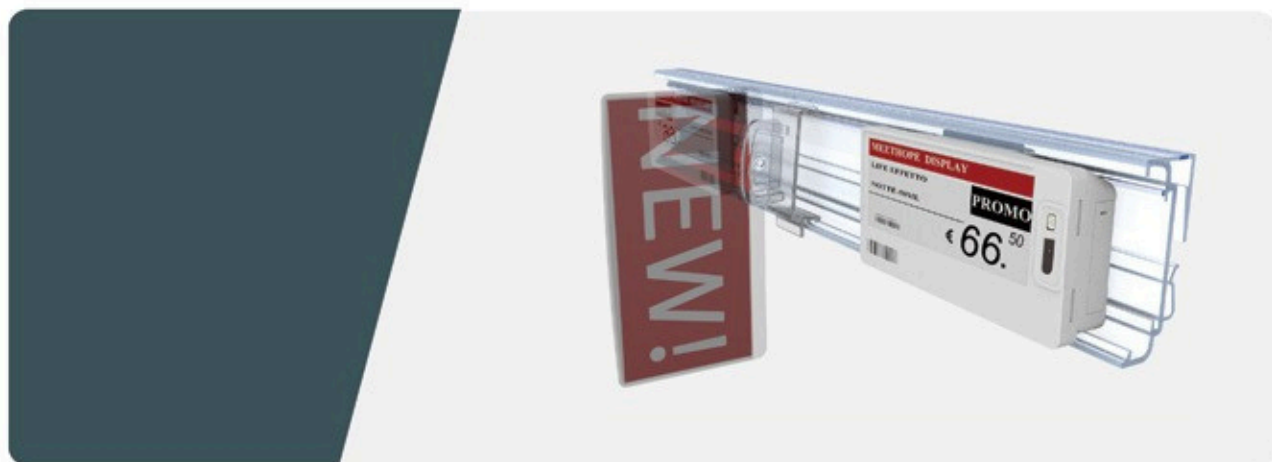

Code: PEE-CKPS02



Code: PEE-CKPL02





Code: PEE-CKPS01

Code: PEE-CKPM01

Code: PEE-CKPL01



How to Use

